

How ZF Meritor's SureShift Transmission Works

ZF Meritor's SureShift transmission shift module enables you to easily shift gears by moving a joystick FORWARD to upshift or BACKWARD to downshift. The joystick signals the transmission control unit (TCU) to activate solenoids to

- Break driveline torque
- Shift into neutral
- Complete a range shift, if necessary
- Synchronize engine speed to match the vehicle's road speed
- Shift into a selected gear

Fault Code Diagnostics

ZF Meritor's SureShift transmission control unit (TCU) uses a series of fault codes to identify system malfunctions that the TCU detects and stores into memory. Each fault code that the TCU lists on the instrument panel display is preceded by either "♦" for an active fault or ":" for an inactive fault.

After you retrieve a fault code from the instrument panel display and identify the fault, use a Volt-ohm meter to test the area where the fault code indicates that the malfunction has occurred. An authorized ZF Meritor distributor or dealer should repair the fault.

For complete maintenance and diagnostics procedures, as well as information on how the SureShift transmission works, refer to Maintenance Manual MM-9970. Call Meritor's Customer Service Center at 800-535-5560 to order this publication, or visit the Technical Library section of Meritor's web site at www.meritorauto.com.

How to Retrieve Active and Inactive Fault Codes From the Instrument Panel Display

NOTE: The vehicle must be stationary to retrieve fault codes.

1. Park the vehicle. Turn the engine OFF, but leave the ignition ON.
2. Prepare to write down the fault codes when the TCU begins to list them on the instrument panel display.
3. Press the NEUTRAL button and the FUNCTION button at the same time and then release both buttons. The transmission control unit (TCU) lists the fault codes on the instrument panel display one at a time. Refer to the table in this guide for a complete list of fault codes and fault code descriptions.
4. When the TCU has listed all of the fault codes on the instrument panel display, the list will stop.
 - **To view the fault codes again:** Press the NEUTRAL button and the FUNCTION button at the same time and then release both buttons. The TCU will list the codes on the instrument panel display.
5. After you record the flash codes, turn the ignition OFF.

How to Clear Active and Inactive Fault Codes From TCU Memory

NOTE: The vehicle must be stationary to clear fault codes.

1. Park the vehicle. Turn the engine OFF. Turn the ignition OFF.
2. Press the NEUTRAL button and the FUNCTION button at the same time and hold both buttons.
3. Turn the ignition ON. **Do not start the engine.**
4. Release both buttons about two seconds after you turn the ignition ON. The fault codes will be cleared from TCU memory.

Instrument Panel and Shift Module Displays



If a system malfunction occurs, the instrument panel display illuminates "SM" for system malfunction; and the shift module display illuminates "F," "N" and "R" and emits a long, repeating beep. When this warning occurs, you will be unable to shift the transmission. Do not continue to operate the vehicle. Serious personal injury and damage to components can result. Safely move the vehicle to the side of the road and call for assistance.

Status	Instrument Panel Display	Shift Module Display
Gear selector position	L, 1-10, N, RL or RH	R, N, or F
Requested shift not available*	CL (Clutch)	Single beep
Torque lock**	CL (Clutch)	Fast, repeating beep
Upshift or downshift being executed	SH (Shift)	F
Shifting from a forward gear to neutral	SH (Shift)	F and N
Shifting from a reverse gear to neutral	SH (Shift)	R and N
Shifting from neutral to a forward gear	SH (Shift)	N and F
Shifting from neutral to a reverse gear	SH (Shift)	N and R
System Malfunction	SM (System Malfunction)	F, N and R; plus a long, repeating beep
Manual Override	MO (Manual Override)	—

* The SureShift™ transmission control unit (TCU) will not allow shifts that require the engine to operate below 1000 rpm or above the engine rating.

** Torque lock occurs when the engine is unable to break torque, which usually occurs when the engine is turning faster than its governed speed.

SureShift Transmission Fault Code Diagnostics



Fault Codes	SAE Codes (PID/SID) ^①	Fault Code Descriptions	Actions Required ^②
C2	SID 194	No Codes	None
A1	PID 161	Main Countershaft Speed Sensor	Verify the resistance across the speed sensor. Inspect the wiring harness for cut or damaged wires.
BF	PID 191	Transmission Output Shaft Speed Sensor	Verify the resistance across the speed sensor. Inspect the wiring harness for cut or damaged wires.
1F	PID 31	Transmission Range Position Sensor	Verify the resistance across the range position sensor. Inspect the wiring harness for cut or damaged wires.
30	SID 48	X-Y Engage Fork Position Sensor	Verify the resistance across the X-Y gear position sensor. Inspect the wiring harness for cut or damaged wires.
3C	PID 60	X-Y Rail Select Position Sensor	Verify the resistance across the X-Y rail position sensor. Inspect the wiring harness for cut or damaged wires.
23	SID 35	High Range Solenoid	Verify the resistance across the high range solenoid. Inspect the wiring harness for cut or damaged wires.
24	SID 36	Low Range Solenoid	Verify the resistance across the low range solenoid. Inspect the wiring harness for cut or damaged wires.
27	SID 39	X-Y Rail Select Solenoid #1	Verify the resistance across the X-Y rail solenoid #1. Inspect the wiring harness for cut or damaged wires.
32	SID 50	X-Y Rail Select Solenoid #2	Verify the resistance across the X-Y rail solenoid #2. Inspect the wiring harness for cut or damaged wires.
28	SID 40	X-Y Engage Fork Solenoid #1	Verify the resistance across the X-Y gear solenoid #1. Inspect the wiring harness for cut or damaged wires.
33	SID 51	X-Y Engage Fork Solenoid #2	Verify the resistance across the X-Y gear solenoid #2. Inspect the wiring harness for cut or damaged wires.
38	SID 56	Auxiliary Section Mechanical System	Inspect the auxiliary section for mechanical concerns.
39	SID 57	Shift Lever Assembly Communication	Inspect the wiring harness connecting the shift lever box to the TCU. ^②

Fault Codes	SAE Codes (PID/SID) ^①	Fault Code Descriptions	Actions Required ^②
3A	SID 58	Main Box Shift Engagement System	Inspect the main box for mechanical concerns.
3B	SID 59	Main Box Rail Selection System	Inspect the top cover for mechanical concerns.
E3	SID 227	Oil Temperature Out of Limits or Sensor	Verify the transmission oil temperature and levels are to specification. Verify the resistance across the oil temperature sensor. Inspect the wiring harness for cut or damaged wires.
E7	SID 231	SAE J-1939 Data Link	Verify the J-1939 connections. Inspect the wiring harness for cut or damaged wires.
EE	SID 238	Diagnostic Lamp	Replace the diagnostic lamp.
FB	SID 251	Power Supply	Verify that the batteries are charged. Inspect the wiring harness for cut or damaged wires.
FC	SID 252	Transmission Calibration Routine	Contact ZF Meritor. ^②
FD	SID 253	Transmission Calibration Memory	Contact ZF Meritor. ^②
FE	SID 254	Transmission Controller	Contact ZF Meritor. ^②
98	SID 152	Shift Lever Box Supply Output	Inspect the wiring harness connecting the shift lever box to the transmission control unit (TCU). ^②
99	SID 153	Limp Home Disable Output	Shift lever box fault. ^②
9A	SID 154	Limp Home System/Function	Shift lever box fault. ^②
97	SID 151	Speed Sensor Plausibility	Verify the resistance across both speed sensors. Inspect the wiring harness for cut or damaged wires.

^① Parameter Identification; Subsystem Identification

^② If necessary, contact Meritor's Customer Service Center at 800-535-5560.

Seat-Mount Wiring Diagram

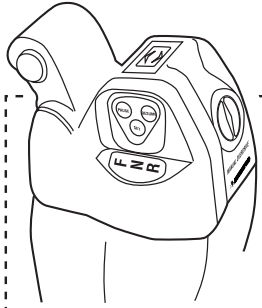

OEM WIRING HARNESS
(schematic omits OEM connectors)

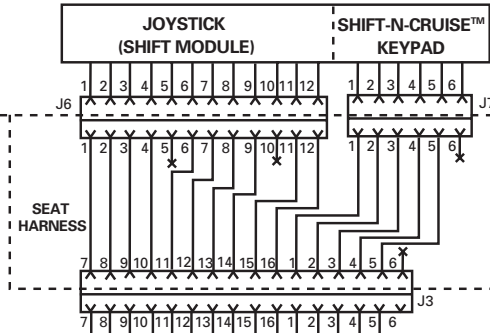

CRUISE CONTROL	
BLACK	— COMMON
WHITE	— (SET)
GREEN	— RESUME
YELLOW	— PAUSE
BLUE	— PAUSE

OEM CONNECTORS

FUNCTION	
BATTERY (+)	
IGNITION (+)	
BATTERY (-)	
CHECK TRANS. LAMP	
SAE J1587 B (-)	
SAE J1587 A (+)	

FUNCTION	
SAE J1939 — CAN_H	
SAE J1939 — CAN_L	
SAE J1939 — CAN_SHLD	

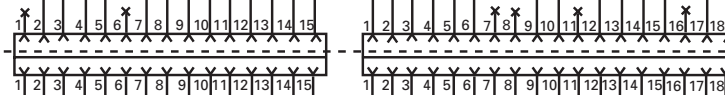

Transmission Control Unit (TCU)

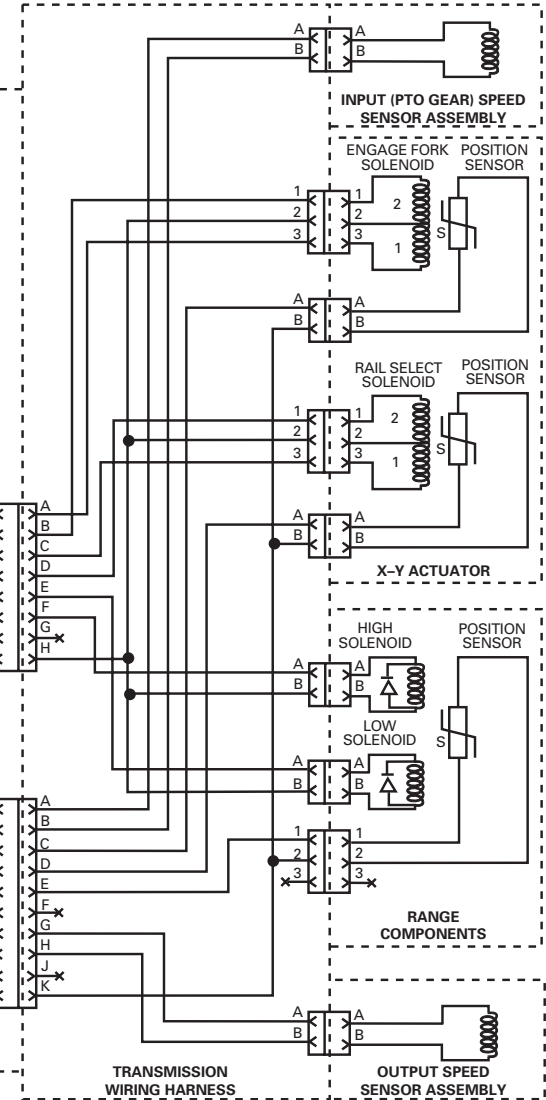

Pedestal-Mount Wiring Diagram

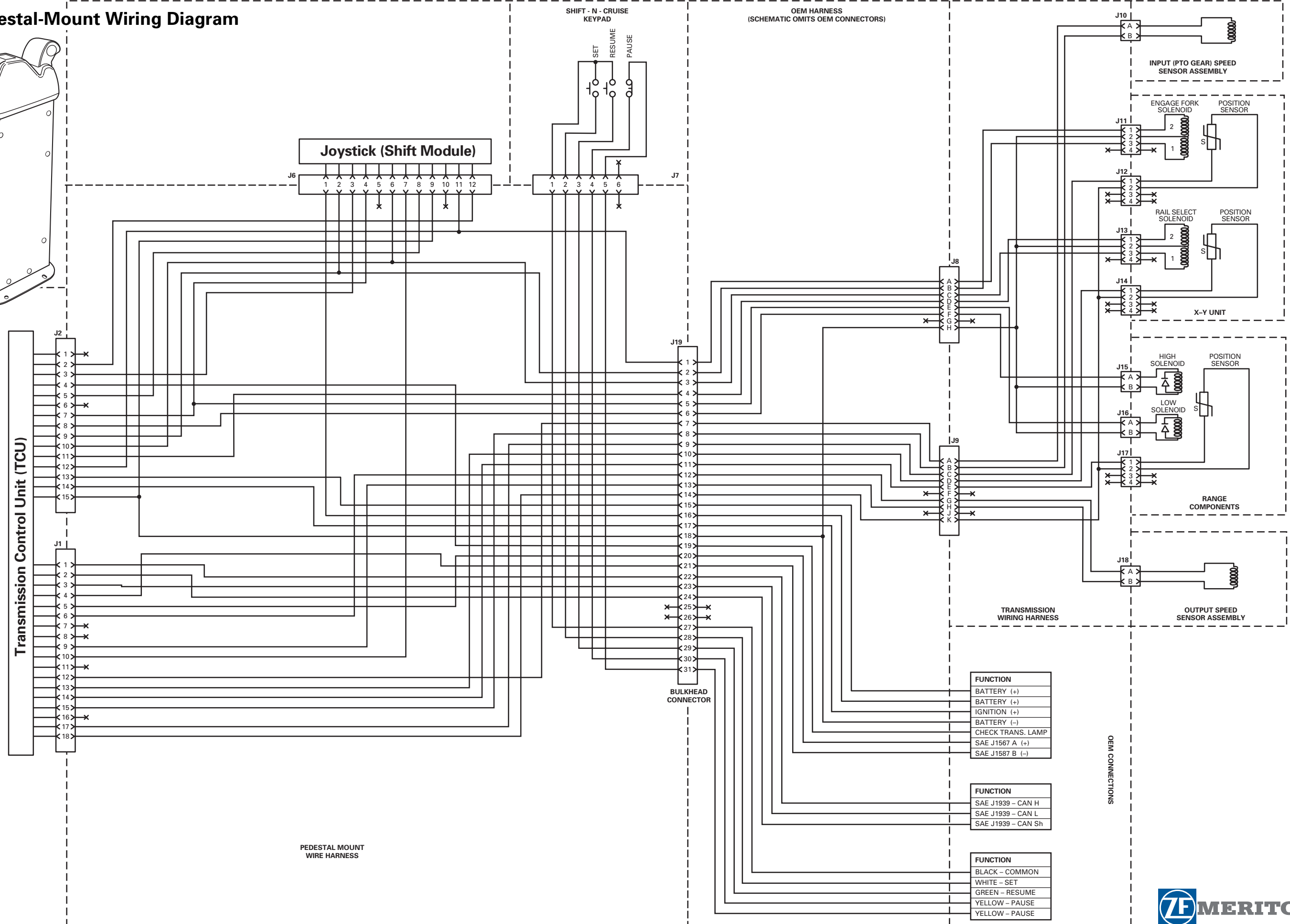
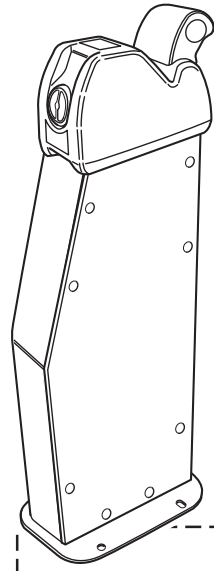

PEDESTAL MOUNT WIRE HARNESS

BULKHEAD CONNECTOR

FUNCTION
BATTERY (+)
BATTERY (+)
IGNITION (+)
BATTERY (-)
CHECK TRANS. LAMP
SAE J1567 A (+)
SAE J1587 B (-)

FUNCTION
SAE J1939 - CAN H
SAE J1939 - CAN L
SAE J1939 - CAN Sh

FUNCTION
BLACK - COMMON
WHITE - SET
GREEN - RESUME
YELLOW - PAUSE
YELLOW - PAUSE

OEM CONNECTIONS

- ① Main Countershaft Speed Sensor
- ② X-Y Position Sensors
- ③ Low Range Solenoid
- ④ High Range Solenoid
- ⑤ Range Position Sensor
- ⑥ Output Shaft Speed Sensor
- ⑦ Rail Select Solenoids
- ⑧ Engage Fork Solenoids

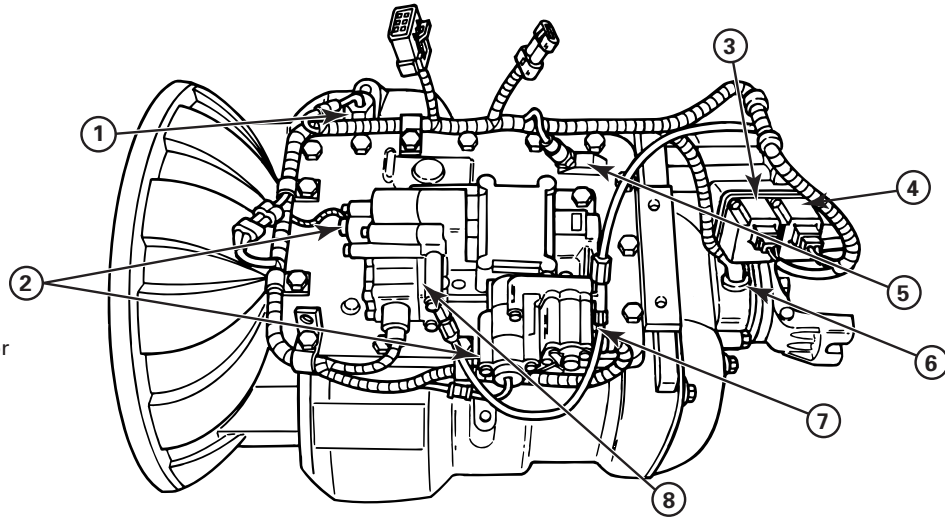

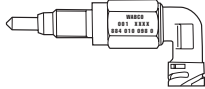
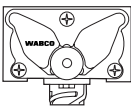
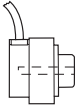
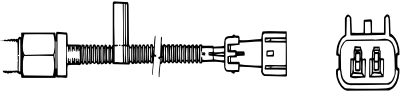
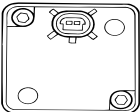
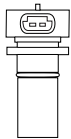
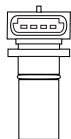
Component		Resistance (Measured Across Pins)
Range Position Sensor		64.80 ohms — 79.20 ohms
Rail Select Solenoids		21.15 ohms — 25.85 ohms
Engage Fork Solenoids		9.63 ohms — 11.77 ohms
X-Y Position Sensors		64.80 ohms — 79.20 ohms
Main Countershaft Speed Sensor		2.70 k ohms — 3.30 k ohms
High and Low Range Solenoids		11.00 ohms — 21.00 ohms
Output Shaft Speed Sensor/ Single Coil	 SINGLE COIL  DUAL COIL	2.00 k ohms — 4.00 k ohms
Output Shaft Speed Sensor/ Dual Coil		1.50 k ohms — 3.50 k ohms

ArvinMeritorTM
Commercial Vehicle Systems

ZF Meritor, LLC
22021 Skyway Church Road
Maxton, NC 28364 USA
800-535-5560
www.arvinmeritor.com

Drivetrain PlusTM by ArvinMeritor



Information contained in this publication was in effect at the time the publication was approved for printing and is subject to change without notice or liability. ArvinMeritor Commercial Vehicle Systems reserves the right to revise the information presented or discontinue the production of parts described at any time.

Copyright 2000
ArvinMeritor, Inc.
All Rights Reserved

Printed in the USA

TP-98114
Revised 10-00
16579/24240